

## Customer

## Supplier

Company name  
Editor  
Phone number  
E-mail

**Fields of Application**

The in-line pumps are designed for:

Water supply and boosting,  
Watering, sprinkling and dewatering,  
Filling and discharging of tanks,  
Circulating of hot and cold water,  
In central heating and air-conditioning installations,  
Circulating in swimming pools,  
Liquid transfer applications in industry, agriculture, etc.  
Pumping of clean and sea water in ships.

**Design Specification**

The INM pumps are single-stage centrifugal pumps of non-self-priming type fitted with standard motors and mechanical shaft seals.

The nominal flow rates of the pumps comply with the DIN 24 255 standards.

Pump flanges sizes according to EN 1092, PN 16. The dimensions of the suction and discharge ports are identical. Both pump flanges have pressure gage tapings.

Single entry, closed impeller is hydraulically thrust compensated and dynamically balanced.

A drain plug is fitted in the bottom of pump housing.

The motor shaft is passed into the pump shaft for coupling and no need to use any coupling for the system.

**Bearings**

For INM series pumps, the motor shaft and pump shaft are passed into each other. The axial and the radial loads are carried by the bearing inside the motor. There is no need to use extra bearing for the pump. For high powers, a coupling system is used between the motor shaft and pump shaft.

**Technical Data**

Suction Flange	: DN 40 - DN 200
Discharge Flange	: DN 40 - DN 200
Operating Pressure	: 10 bar
Operating Temperature	: -25 – 120 °C
Flow Range	: 2 – 520 m <sup>3</sup> /h
Head Range	: 2 - 105 m
Speed Range	: 900-3600 rpm

**Customer**
**Supplier**

Company name  
Editor  
Phone number  
E-mail

**Operating data specification**

Pumped fluid	Water		Rated flow		m <sup>3</sup> /h
Solids			Rated head		m
Kind			Geodetic head		m
Percentage of solid content	0		Available system NPSH		m
pH value			Inlet pressure (pin)	0	kPa
Temperature	20	°C	Altitude above sea level	100	m
Density	998.3	kg/m <sup>3</sup>	Max. operating pressure	389	kPa
Kin. viscosity	1.005	mm <sup>2</sup> /s	Max. diff. pressure	389	kPa
Vapour pressure	2.34	kPa			

**Pump**

Make	MAS DAF		Impeller type		
Pump type	INM 65-200		Impeller construction		
Frame size			Impeller Ø		
Design			Max.	218	mm
Self priming	<input checked="" type="checkbox"/> No		designed	176	mm
Speed	2900	1/min	Min.	150	mm
Stages	1		Flow		
Suction port			Nominal	52.9	m <sup>3</sup> /h
Pressure rating	PN16		Max.	68.8	m <sup>3</sup> /h
Nominal pipe size	DN65		Min.	0	m <sup>3</sup> /h
Standard	DIN		Head		
Discharge port			Nominal	33	m
Pressure rating	PN16		Min.	23.8	m
Nominal pipe size	DN65		Max.	39.7	m
Standard	DIN		Shut off head	39.7	m
Shaft power		kW	NPSH3		m
Shaft power P2(Q=max.)	7.94	kW	Efficiency		%

**Motor**

Make/Type	7.5 KW-2900 RPM / 132S	
Specific design	IE3 / 50 Hz / Pole pairs 1	
Rated power	7.5	kW
Electric voltage	3~ 400	V
Speed	2910	1/min
Electric current	13.3	A
Frame size	132S	
Degree of protection	IP 55	
Type of protection		
Explosion protection		

**Coupling**

Make/Type	
Series	
Spacer length	mm
Frame size	

**Materials**

Pump		Shaft seal	AQ1EGG
Pump Casing	GJL-250 (GG25)	Material code	AQ1EGG
Impeller	GJL-250 (GG25)	Seal face	Carbon graphite antimony impregnated (A)
Shaft	A 276 Type 420 (X20Cr13)	Seat	Silicon carbide (Q1, eSiC-Q7)
		Elastomer	EPDM (E)
		Metal parts	CrNiMo steel (G)

Customer

Supplier

Company name  
Editor  
Phone number  
E-mail

Power data referred to: Water; 20°C; 998.3kg/m<sup>3</sup>; 1.005mm<sup>2</sup>/s Sense of rotation Clockwise from the drive end

Missing or invalid parameter (REFDIAM)

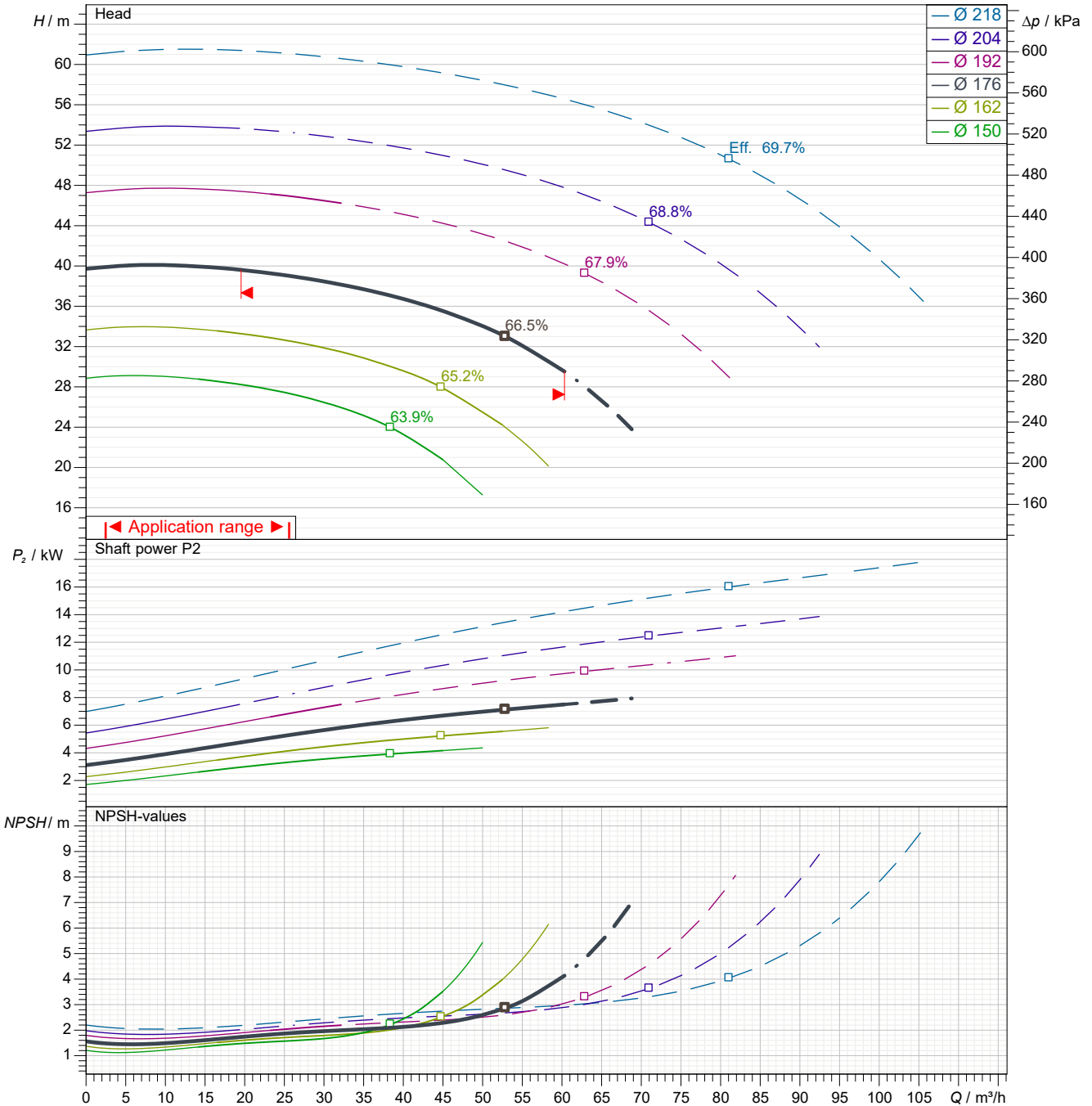

Pump curves in accordance with ISO 9906 2B

Pumped fluid	Water		Rated flow	m <sup>3</sup> /h
Temperature	20	°C	Rated head	m
Density	998.3	kg/m <sup>3</sup>	Shaft power	kW
Kin. viscosity	1.005	mm <sup>2</sup> /s	Speed	2900 1/min
Vapour pressure	2.34	kPa	NPSH3	m
Impeller Ø	176	mm	Efficiency	%

Subject to change

Projec

Issue date  
2022-04-06

Last update  
2022-04-06

Customer

Supplier

Company name  
Editor  
Phone number  
E-mail

**Performance curves**

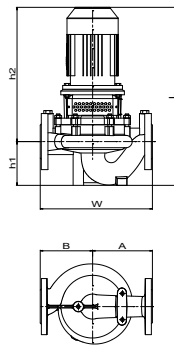
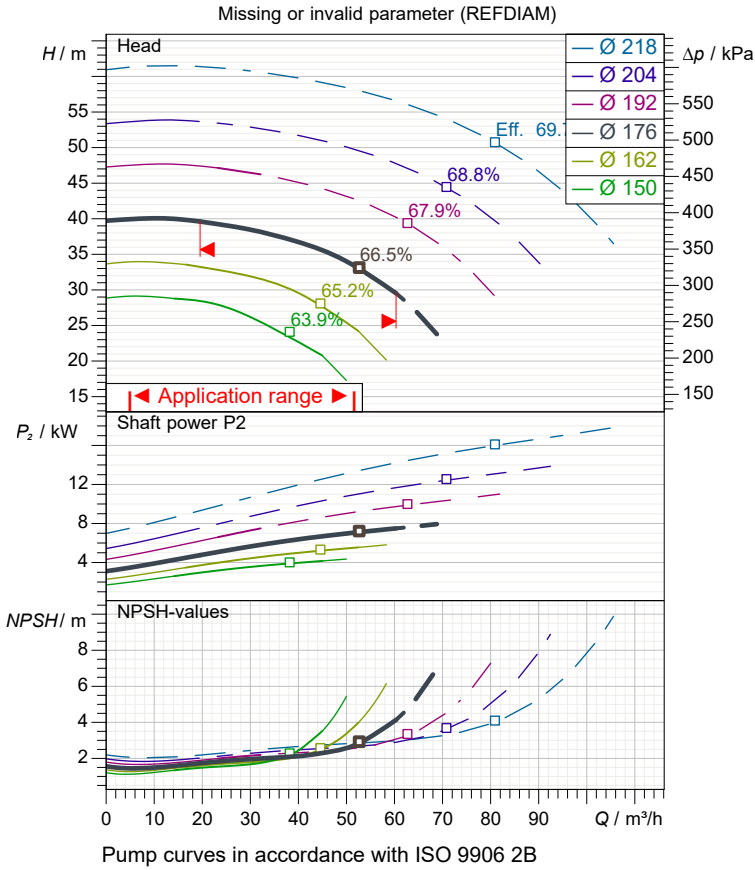

**Dimensions**

	mm
A	230
B	230
h1	115
h2	622
L	737
w	460

**Pump**

Make	MAS DAF
Pump type	INM 65-200
Design	
Suction port	
Pressure rating	PN16
Nominal pipe size	DN65
Standard	DIN
Discharge port	
Pressure rating	PN16
Nominal pipe size	DN65
Standard	DIN

**Operating data specification**

Pumped fluid	Water	
Temperature	20	°C
Density	998.3	kg/m <sup>3</sup>
Kin. viscosity	1.005	mm <sup>2</sup> /s
Vapour pressure	2.34	kPa
Rated flow		m <sup>3</sup> /h
Rated head		m
Shaft power		kW
Speed	2900	1/min
NPSH3		m
Efficiency		%
Impeller Ø	176	mm

**Motor**

Make/Type	7.5 KW-2900 RPM / 132S
Specific design	IE3 / 50 Hz / Pole pairs 1
Rated power	7.5 kW
Speed	2910 1/min
Electric voltage	3~ 400 V
Electric current	13.3 A
Degree of protection	IP 55

**Materials**

Shaft seal	AQ1EGG
Material code	AQ1EGG
Seal face	Carbon graphite antimony impregnated (A)
Seat	Silicon carbide (Q1, eSiC-Q7)
Elastomer	EPDM (E)
Metal parts	CrNiMo steel (G)

Pump Casing	GJL-250 (GG25)
Impeller	GJL-250 (GG25)
Shaft	A 276 Type 420 (X20Cr13)

Customer

Supplier

Company name  
Editor  
Phone number  
E-mail

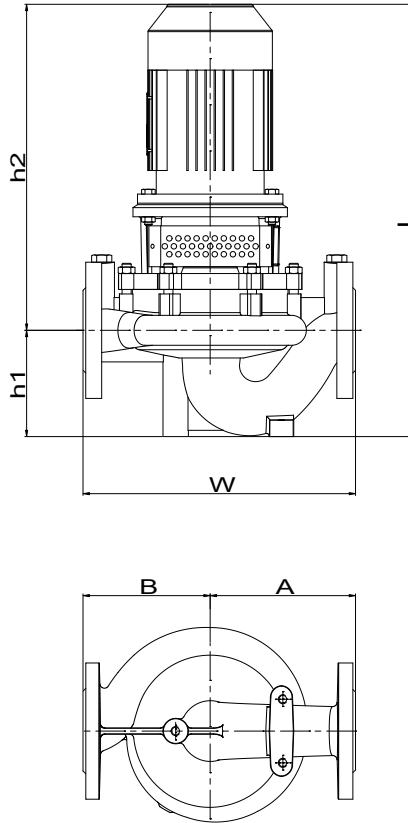

Dimensions	mm	Inlet / outlet	
A	230	Suction port	Discharge port
B	230	DN65	DN65
h1	115	PN16	PN16
h2	622		
L	737		
w	460		

Customer

Supplier

Company name  
Editor  
Phone number  
E-mail

**motor data**

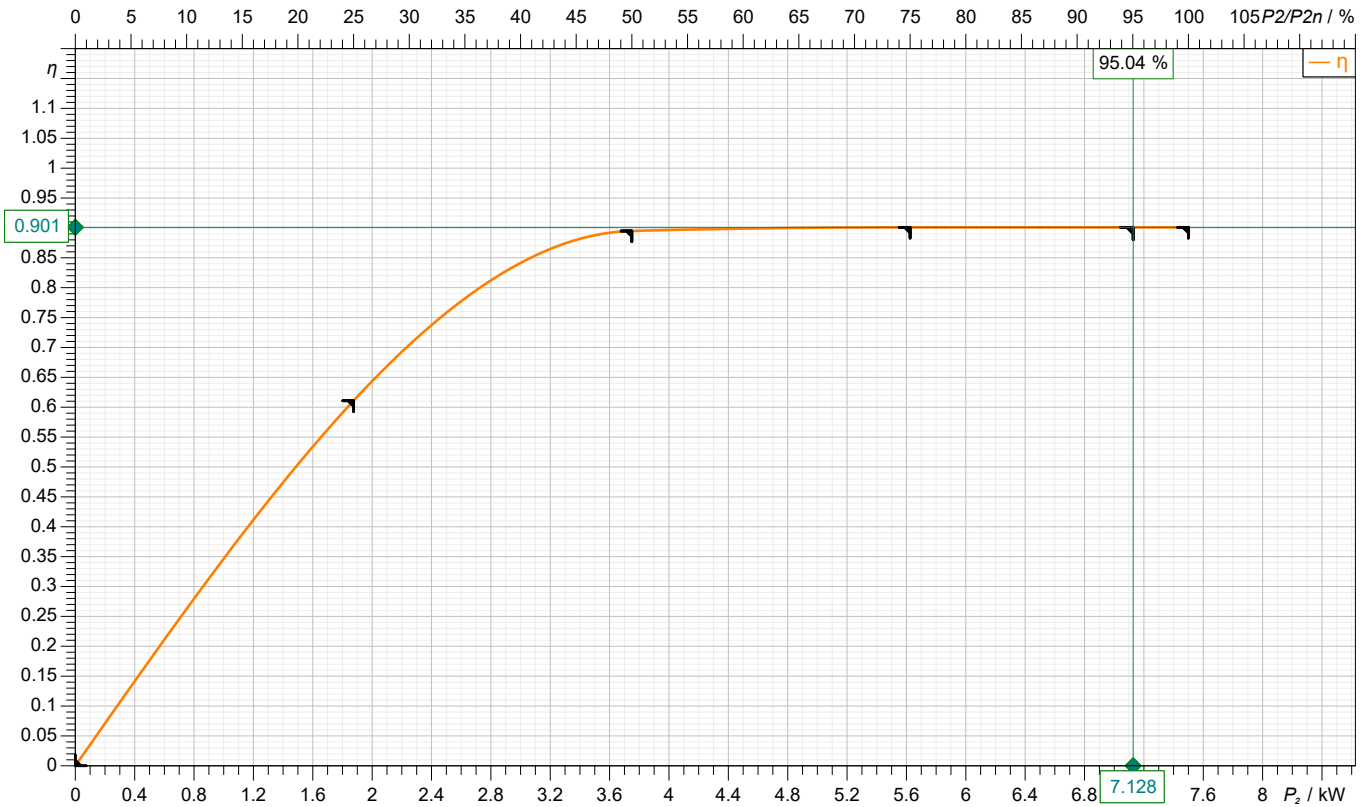

Symbol	No load	25 %	50 %	75 %	100 %	125 %
$P_2$ / kW	0	1.875	3.75	5.625	7.5	
$P_1$ / kW		3.069	4.19	6.243	8.324	
$\eta$ / %	0	61.09	89.5	90.1	90.1	

**Motor**

Make/Type	7.5 KW-2900 RPM / 132S	Degree of protection	IP 55
Specific design	IE3 / 50 Hz / Pole pairs 1	Type of protection	
Rated power	7.5 kW	Explosion protection	
Electric voltage	3~ 400 V	Service factor	1.15
Number of poles	2	Starting current	
Speed	2910 1/min	Starting torque	
Electric current	13.3 A	Moment of inertia	
Power factor	0.9	No. starts per hour	
Frame size	132S	Rated torque	24.6 Nm
Efficiency class	IE3	Insulation class	F (155C°)

Customer

Supplier

Company name  
Editor  
Phone number  
E-mail

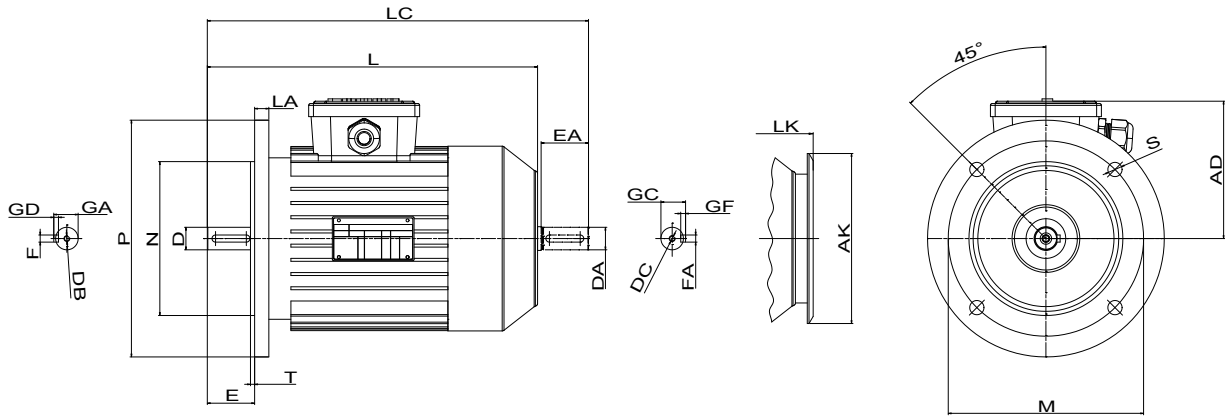

Dimensions	mm		
AD	168	LK	535
AK	239	M	265
D	38	N	230
DA	38	NO	4
DB	M12	P	300
DC	M12	S	14.5
E	80	T	4
EA	80		
FAxGF	10X8		
FxGD	10X8		
GA	41		
GC	41		
L	498		
LA	20		
LC	584		

Customer

Supplier

Company name  
Editor  
Phone number  
E-mail

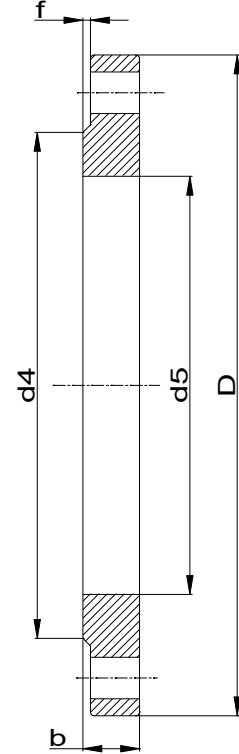

**Suction connection**

DN65  
PN16

**Discharge connection**

DN65  
PN16

Dimensions	mm
b	20
D	185
d2	18
d4	122
d5	77.5
DN	65
f	2
k	145
n	8

Dimensions	mm
b	20
D	185
d2	18
d4	122
d5	77.5
DN	65
f	2
k	145
n	8





**Spare part list**  
INM 65-200

Revision number

Page  
9

Company name  
Editor  
Phone number  
E-mail

**Customer**

**Supplier**

**Subject to change**

Projec

Issue date  
2022-04-06

Last update  
2022-04-06



**Spare part list**  
INM 65-200

Revision number

Page  
10

Company name  
Editor  
Phone number  
E-mail

**Customer**

**Supplier**

**Subject to change**

Projec

Issue date  
2022-04-06

Last update  
2022-04-06